



Technical Data

Specification & Capacities



SPX312



CP: 7,6kW/10,4Hp



C+: 4,0kW/5,5Hp



2,2-7,6m



1200kg









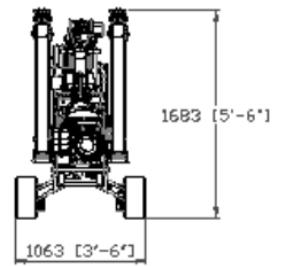
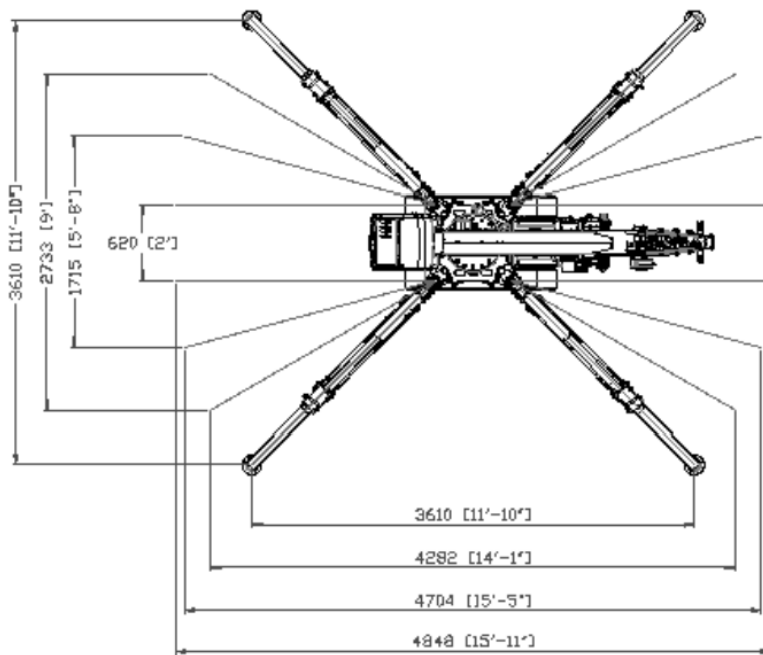
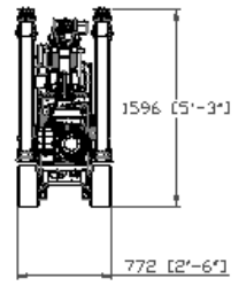
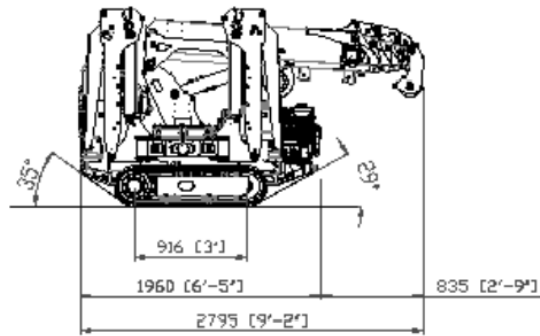

Via Campardone, 7
31014 Colle Umberto – Italy
Tel. +39 0438 434443
Mail: info@jekko.it
Web: www.jekko.it





Author	Zava M.
Date	04-2014
REV.	06



SPX312 - OVERALL DIMENSIONS



		kg	lbs
		1800	3968
		0	0
Tot.		1800	3968

	YAMAHA MZ 360		7,6kW 10,4Hp	
			GASOLINE	
			l	6
			gal	1,59
	n°4 6V 240Ah		24V-3F 4,0kW 5,5Hp	

	km/h	1,7
	mph	0,62
	20°	
	kg/cm ²	0,44
	lbs/ftq	901
	kg	1400
	lbs	3086

	0°/75°		24"
	280°		1,0 rpm
	m	2,2-7,6	40"
	ft	7'2"-24'9"	

HOIST PERFORMANCE

Layer	Max Line Pull		Normal Line Speed		High Line Speed	
	kg	Lbs	m/min	ft/min	m/min	ft/min
1	600 (*)	1.320 (*)	12.2	40.0	25.7	84.3
2	600 (*)	1.320 (*)	13.3	43.6	28.0	91.8
3	600 (*)	1.320 (*)	14.0	45.9	29.5	96.8
4	600	1.320	15.1	49.5	31.8	104.0

(*) LMI limited



Wire Rope	Diameter		Tot. Length		Max Load	
	mm	in	m	ft	kg	lbs
A4L 19x7 right lang lay	7	5/16	63	210	3.600	7.920

HOOK BLOCK

LOAD		No. of	
kg	lbs	Sheaves	Lines
1200	2646	1	2
600	1323	-	1

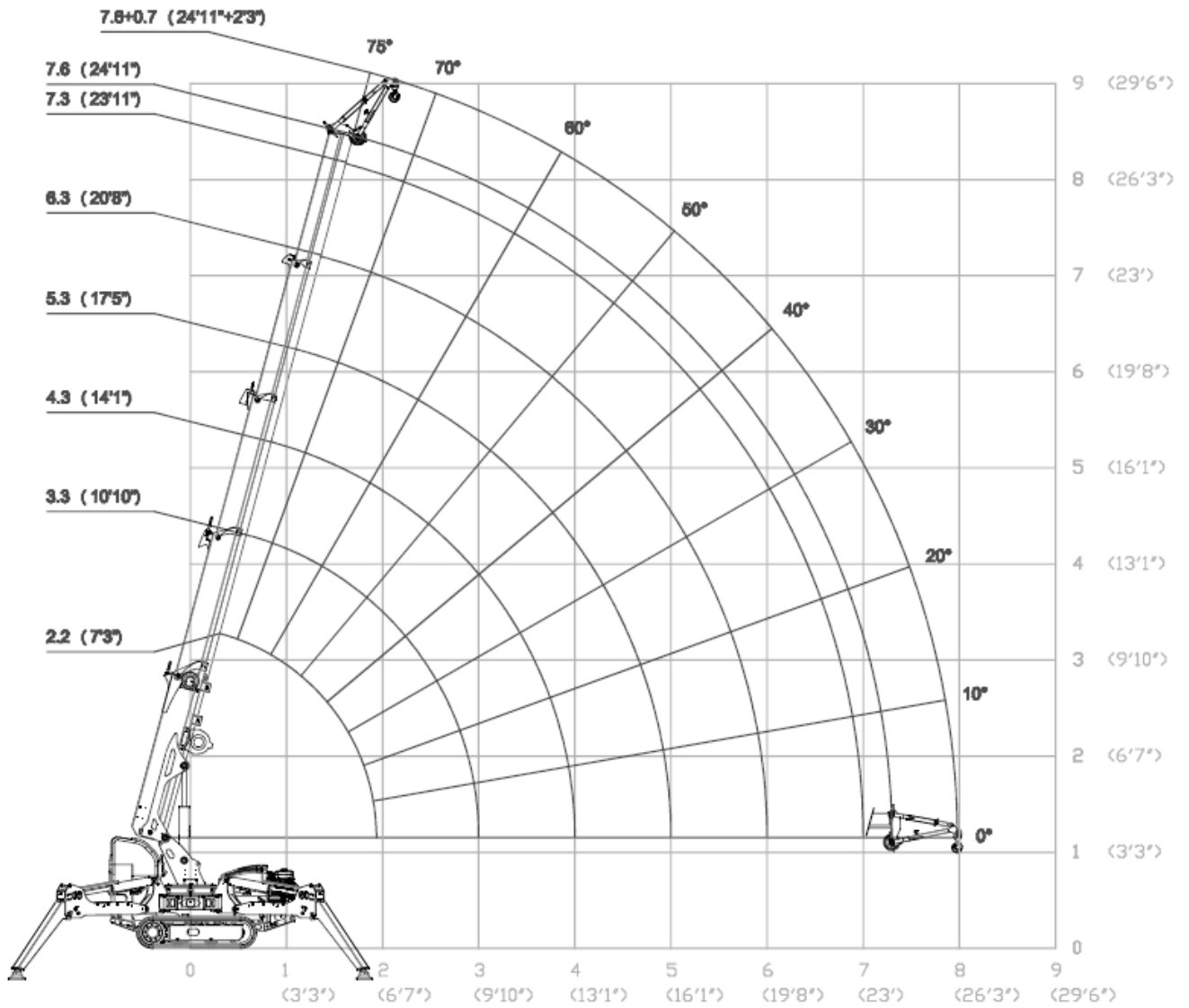

SPX312 + JIB800GX

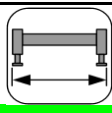
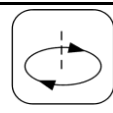
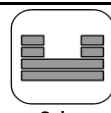

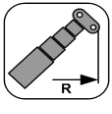
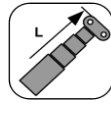
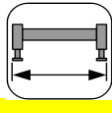
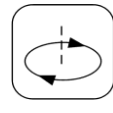
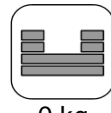

							
	2,2	3,3	4,3	5,3	6,3	7,3	7,6
	7,22	10,83	14,11	17,39	20,67	23,95	24,93
1,0	1200	1200	1050				
3,28	2640	2640	2310				
2,0		1200	1200	1100	900	650	600
6,56		2640	2640	2420	1980	1430	1320
3,0		1000	1000	900	800	650	600
9,84		2200	2200	1980	1760	1430	1320
4,0			830	780	650	550	500
13,12				1716	1430	1210	1100
5,0				590	550	480	400
16,40				1298	1210	1056	880
6,0					420	380	350
19,69					924	836	770
7,0						320	300
22,97						704	660
7,3							300
23,95							660

							
	2,2	3,3	4,3	5,3	6,3	7,3	7,6
	7,22	10,83	14,11	17,39	20,67	23,95	24,93
1,0	1200	1200	1050				
3,28	2640	2640	2310				
2,0		1050	1050	950	800	550	500
6,56		2310	2310	2090	1760	1210	1100
3,0		900	900	800	720	550	500
9,84		1980	1980	1760	1584	1210	1100
4,0			520	490	390	330	300
13,12			1144	1078	858	726	660
5,0				340	320	270	220
16,40				748	704	594	484
6,0					250	220	200
19,69					550	484	440
7,0						180	180
22,97						396	396
7,3							150
23,95							330

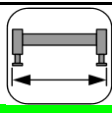
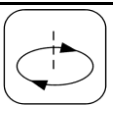
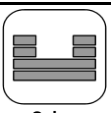
kg/m
lbs/ft

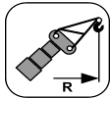
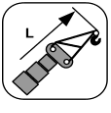
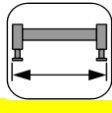
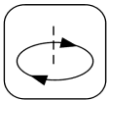
	   										
	JIB800GX	100%	330°	0 kg 0 lbs	2,9	3,3	4,3	5,3	6,3	7,3	8,3
	9,51	10,83	14,11	17,39	20,67	23,95	27,23				
1,0	800	800	800								
3,28	1760	1760	1760								
2,0		800	800	800	800	650	600				
6,56		1760	1760	1760	1760	1430	1320				
3,0		800	800	800	800	650	600				
9,84		1760	1760	1760	1760	1430	1320				
4,0			800	780	650	550	500				
13,12			1760	1716	1430	1210	1100				
5,0				590	550	480	400				
16,40					1210	1056	880				
6,0					420	380	350				
19,69					924	836	770				
7,0						320	300				
22,97						704	660				
8,0							200				
26,25							440				



	   										
	JIB800GX	50%	330°	0 kg 0 lbs	2,9	3,3	4,3	5,3	6,3	7,3	8,3
	9,51	10,83	14,11	17,39	20,67	23,95	27,23				
1,0	800	800	800								
3,28	1760	1760	1760								
2,0		800	800	800	800	550	500				
6,56		1760	1760	1760	1760	1210	1100				
3,0		800	800	800	720	550	500				
9,84		1760	1760	1760	1584	1210	1100				
4,0			520	490	390	330	300				
13,12			1144	1078	858	726	660				
5,0				340	320	270	220				
16,40				748	704	594	484				
6,0					250	220	200				
19,69					550	484	440				
7,0						180	180				
22,97						396	396				
8,0							100				
26,25							220				

kg/m
lbs/ft

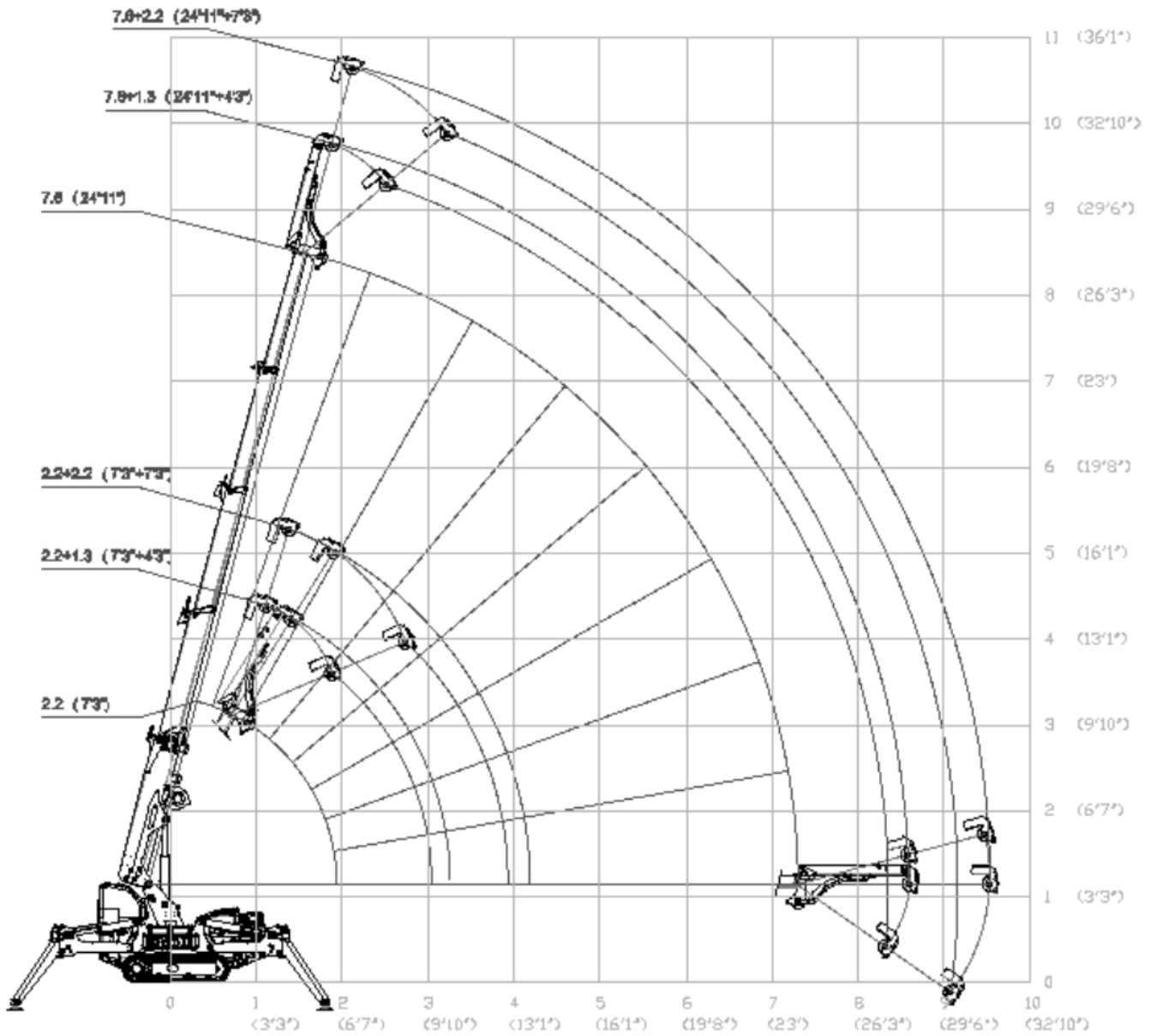
SPX312 + JIB400.1MX

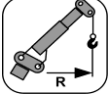
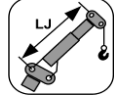
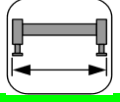
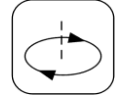
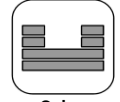

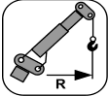
				
	JIB400.1MX	100%	330°	0 kg 0 lbs
	1,3	2,2		
	4,27	7,22		
2,0	400	300		
6,56	880	660		
3,0	400	300		
9,84	880	660		
4,0	400	300		
13,12	880	660		
5,0	400	300		
16,40	880	660		
6,0	350	300		
19,69	770	660		
7,0	250	250		
22,97	550	550		
8,0	200	200		
26,25	440	440		
8,6	150	150		
28,22	330	330		
9,6		100		
31,50		220		

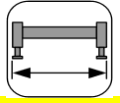
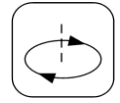
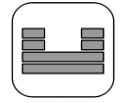
				
	JIB400.1MX	50%	330°	0 kg 0 lbs
	1,3	2,2		
	4,27	7,22		
2,0	400	300		
6,56	880	660		
3,0	400	300		
9,84	880	660		
4,0	400	300		
13,12	880	660		
5,0	300	250		
16,40	660	550		
6,0	200	200		
19,69	440	440		
7,0	100	100		
22,97	220	220		

kg/m

lbs/ft

JIB800GX

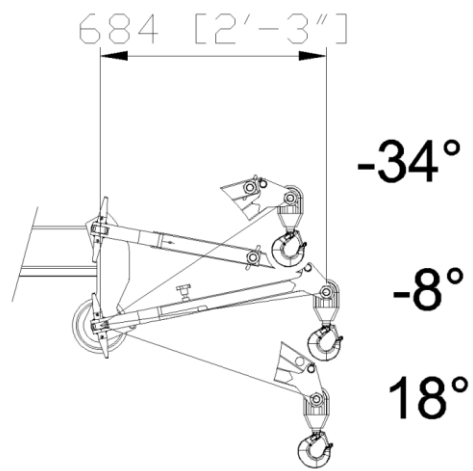

JIB400.1MX

